



UK Government

**NHS**

Test and Trace

# How to test yourself for coronavirus (COVID-19) at home



This is an easy read guide.

January 2021

# Introduction



Department  
of Health &  
Social Care

This guide comes from the Government's Department of Health and Social Care.

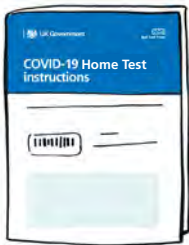

It tells you:

- what to do when you get your test kit.
- how to test yourself for **coronavirus**.

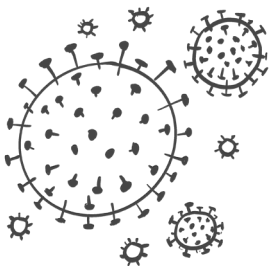

**Coronavirus** is an illness that is spreading around the world. Lots of people call it COVID-19.



We have a test for coronavirus. You can do the test on yourself.



## Coronavirus

You can have coronavirus and not feel ill.



Some people are very ill with it.



## Coronavirus symptoms

You may get a high temperature and a cough.



You might not be able to taste or smell things.

If you have **any** coronavirus symptoms you must **isolate** and can book a test.

**Isolate** means:

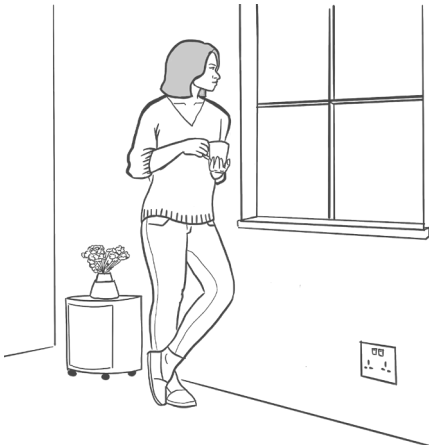

- you must stay in your home.



- you cannot go near other people.



- you cannot go out.

# Register the test kit



**Register** means tell the Government that you are about to do a test and send it back to them.

You must register your test kit, otherwise you will not receive your test result.

Register your test by going to:  
[www.gov.uk/register-home-test](https://www.gov.uk/register-home-test)

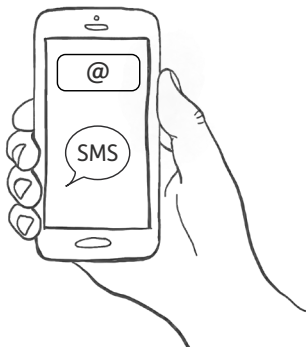

To register you will need:

- **your order ID.** It is made up of 10 numbers. You can find this in the text or email you received.
- **your test kit barcode.** It is made up of 11 letters and numbers. This barcode is on your booklet, plastic tube, leak-proof bag and return box.

# Prepare to test

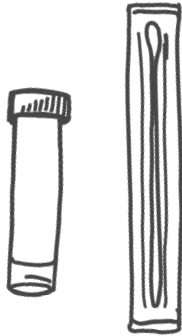

The test is nothing to worry about. It will be very quick and it will not hurt.



Clean and dry a surface. Then unpack everything from the test kit onto it.



If you have a runny nose, you will need to blow your nose with a tissue before taking the test. Throw the used tissue in a bin.



Before you take the test, wash your hands with soap and water.



You will take the test from your throat and your nose using the **swab**.

A **swab** is like a large cotton bud.

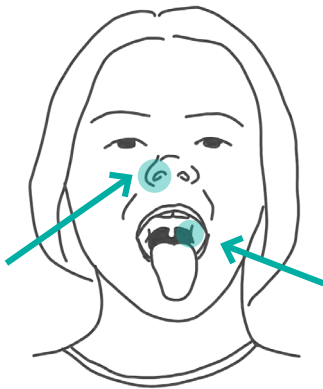

You will use the same swab for both your throat and your nose.

**If you cannot swab your throat,** you can swab both nostrils instead.

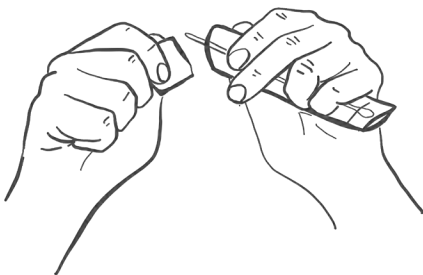

Open the package and gently take out the **swab**, holding it at the stick end.

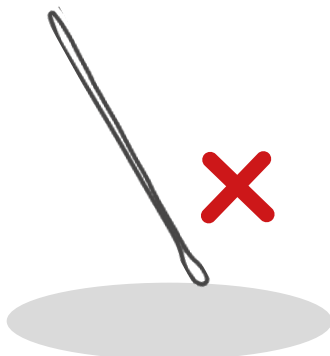

Do not let the tip of the swab touch other surfaces or it could mix up your results.

# Throat swab

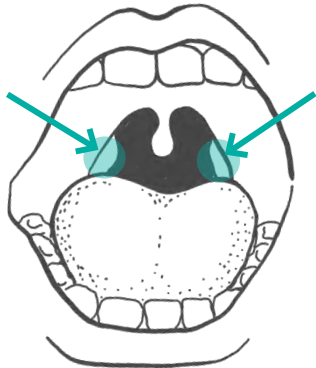

Look inside your mouth and find your **tonsils**. Your **tonsils** are the soft parts at the back of your throat.



You need to open your mouth and stick out your tongue.

Use the swab to take a sample from your throat.

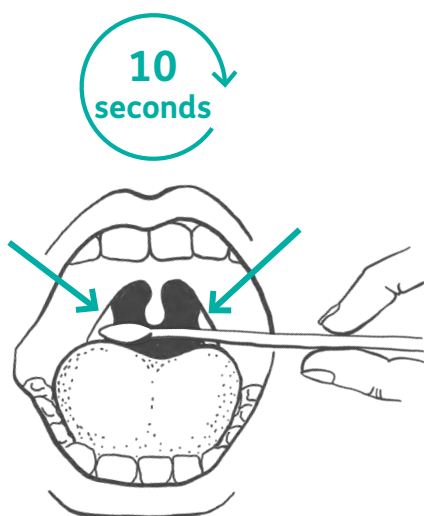

Gently rub the swab over the soft parts at the back of your throat for **10 seconds**.

It may be a bit uncomfortable and may make you gag, but it will not hurt.



# Nose swab

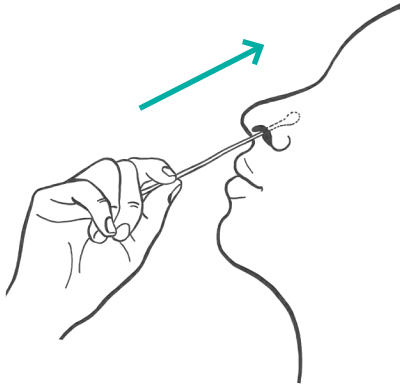

Use the same swab to take a sample from your nose. If one of your nostrils is pierced, swab the other nostril.

Put the swab into your nostril and push it gently upwards.

It will not hurt and it will not go too far up.



Gently turn the swab for **10-15 seconds**. This will not hurt but may be a bit uncomfortable.

If you did not swab your throat, now swab the second nostril.

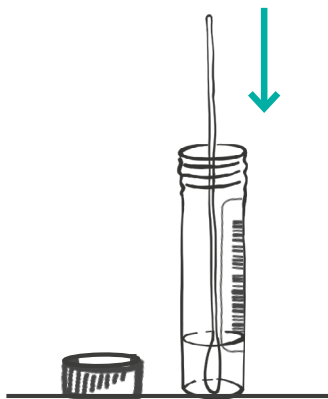

Put the swab into the **plastic tube**. A **plastic tube** is a small jar filled with a little liquid.

Make sure the liquid stays in the tube.

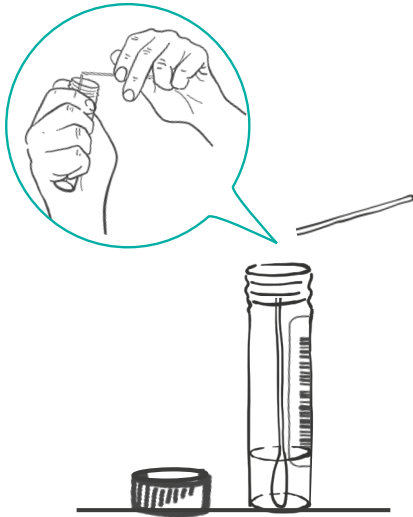

Snap off the stick end of the swab so that it fits into the plastic tube without bending.



Screw the lid of the plastic tube back on tightly and check it is on correctly.



That is it, well done.  
Now you need to pack it up and send it back.

# Pack up your test

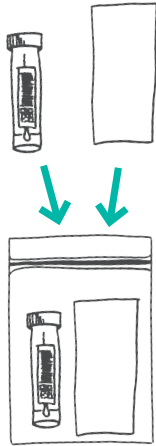

An **absorbent pad** is a small piece of soft fabric.

Place the plastic tube and absorbent pad together into the zip lock bag.

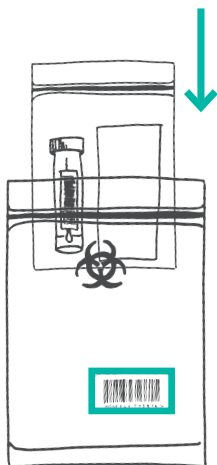

Then, put the zip lock bag into the **biohazard bag**.

The biohazard bag will have a barcode on it.

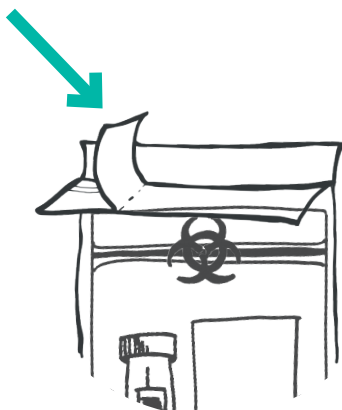

Let some air out of the bag. Then take the sliver strip off the top of the bag. There is a sticky area underneath. Press the top of the bag together to close it.

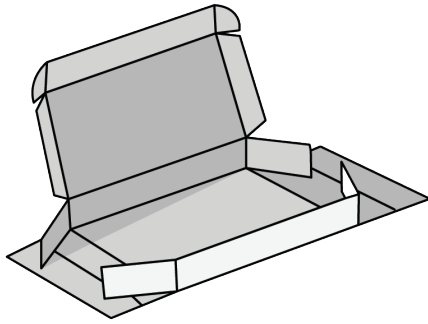

Make up the cardboard box by folding it along the lines.

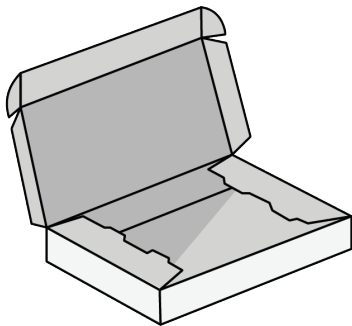

First, fold all 4 sides towards the centre to make it into a box shape.

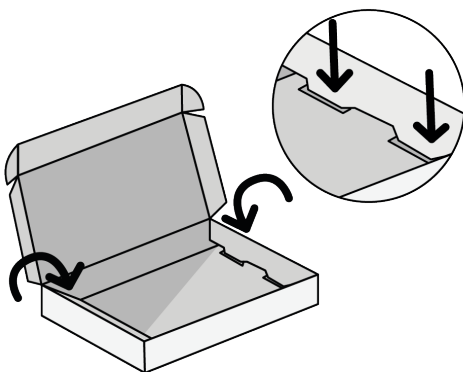

Then, fold the left and right flaps downwards and push them into the holes on the base. This will hold the sides in place.

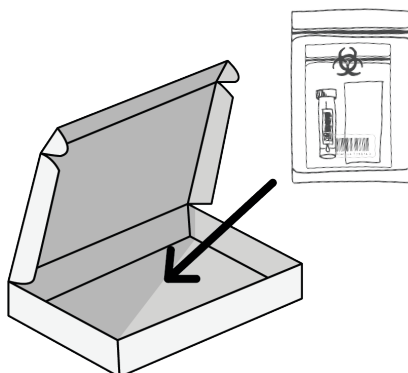

Put the bag inside your cardboard box.

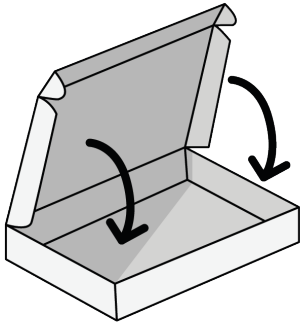

Fold the top part of the lid and push it into the bottom part to close the box.

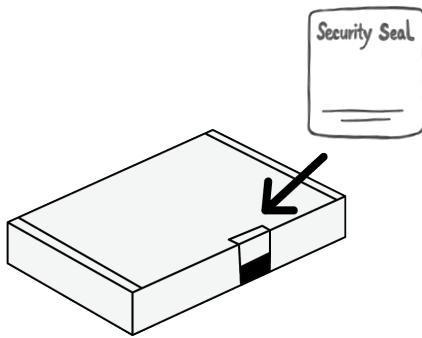

Tape it shut with the security seal.

## **PLEASE DO NOT RETURN YOUR TESTING KIT VIA POST.**

You can ignore the address provided in the home testing kit. Instead, return as described below.

Please ensure all test kits are returned the same working day as they are used, or the following day at the latest.

This is to ensure that the samples can be tested in time.

Return completed tests to your nearest Hub or hand back to a home test kit collector when they call on you.

# Get your test results



You will not know the test results straight away. It will be sent off to the lab for testing.

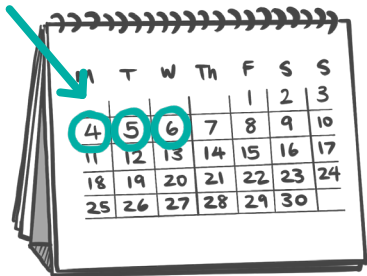

You will have to wait for your test results. This may take up to 3 days.



If you or a person you live with have any coronavirus symptoms, continue to self-isolate while you wait for your test results.

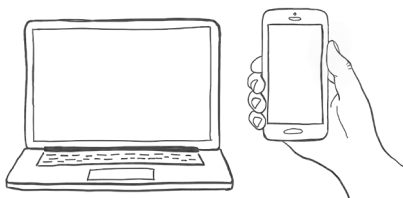

You will get your test results by text and email.

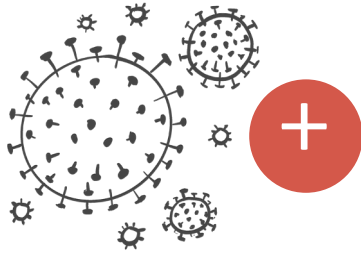

## If your test result is positive

It means that you have coronavirus.

If you also have symptoms, you must **isolate for 10 days from when your symptoms started.**

If you have not had symptoms you must **isolate for 10 days from when you had the test.**

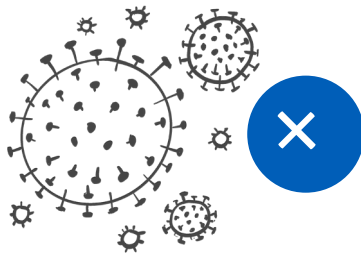
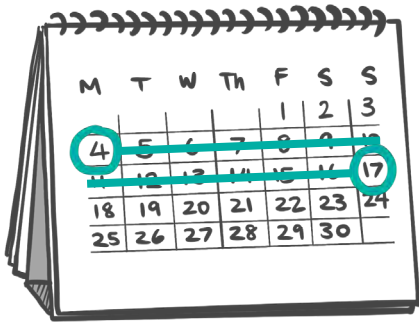

## If your test result is negative

It means that the test did not find coronavirus.

You do **not** need to continue isolating as long as:

- no one else in your home has symptoms
- NHS Test and Trace did not tell you to self-isolate
- you feel well. If you feel unwell, stay at home until you feel better



**NHS**  
Test and Trace



# For more information



If you need more information, please go to:

[www.gov.uk/government/publications/supported-living-services-during-coronavirus-covid-19](https://www.gov.uk/government/publications/supported-living-services-during-coronavirus-covid-19)

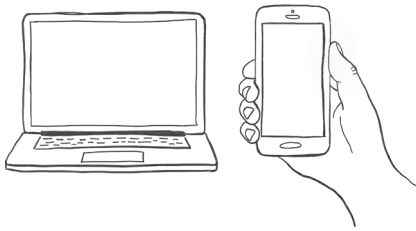

If you have any questions about your coronavirus test please call:

- **119** if you live in England, Wales or Northern Ireland
- **0300 303 2713** if you live in Scotland

Lines are open **7am to 11pm** every day.



If you feel worse, or you do not get better after 7 days:

- visit NHS 111 online at [www.111.nhs.uk](https://www.111.nhs.uk)
- or call **111**